

mira
Sport
Max



ELECTRIC SHOWER

Installation & User Guide

THESE INSTRUCTIONS ARE TO BE LEFT WITH THE USER

Contents

Section	Page
1 Introduction	3
2 Important Safety Information	4
3 Pack Contents Checklist	6
4 Specifications	7
5 Installation Requirements	8
6 Installation	12
7 Commissioning	16
8 User Instructions	18
9 Fault Diagnosis	23
10 ... Maintenance	27
11 ... Dimensions	28
12 ... Wiring Diagram	29
13 ... Accessories	30
14 ... Spare Parts	30
15 ... Customer Service	Back Page

Introduction

Thank you for purchasing a quality Mira product. To enjoy the full potential of your new product, please take time to read this guide thoroughly. Having done so, keep it handy for future reference.

The Mira Sport Max is an electric shower with separate controls for power selection and temperature/flow adjustment. A unique flow regulator stabilizes temperature changes caused by water pressure fluctuations. These can result from taps being turned on or off or toilets being flushed. Individual lights indicate "LOW FLOW" and "OVERHEAT". Power "ON" is indicated by illuminated rings around the buttons.

This shower comes complete with a set of Mira Logic Electric Shower Fittings.

Mira Sport product covered by this guide:

Mira Sport Max - A 10.8 kW 240 V AC (9.9 kW 230 V AC) heater. Available in white/chrome and white finishes.

Mira Shower Fittings covered by this guide:

Mira Logic Electric Shower Fittings

An adjustable spray handset with four different spray actions (start, soothe, force and eco), supplied complete with flexible hose, clamp bracket assembly, slide bar, supports, soap dish/hose retaining ring. Available in white/chrome and white finishes.

If you experience any difficulty with the installation or operation of your new shower control, then please refer to the **Fault Diagnosis** section before contacting Kohler Mira Ltd. Our telephone and fax numbers can be found on the back cover of this guide.

Important Safety Information

1. Warning!

- 1.1. Products manufactured by us are safe and without risk provided they are installed, used and maintained in good working order in accordance with our instructions and recommendations.
- 1.2. **THIS APPLIANCE MUST BE EARTHED. MAKE SURE SUPPLEMENTARY BONDING COMPLIES WITH THE "REQUIREMENTS FOR ELECTRICAL INSTALLATIONS".**

The installation must be in accordance with the current edition of BS 7671 "The IEE Wiring Regulations" in force at the time of installation. This appliance is intended to be permanently connected to the fixed electrical wiring of the mains system with its own dedicated supply.

- 1.3. **DO NOT** twist the individual cable cores of the live and neutral conductors, as this will prevent them from entering the terminal block.
- 1.4. The shower unit must **NOT** be fitted where it may be exposed to freezing conditions. Make sure that any pipework that could become frozen is properly insulated.
- 1.5. **DO NOT** fit any form of outlet flow control as the outlet acts as a vent for the tank body. Only Mira recommended outlet fittings should be used.
- 1.6. If the cover is removed, the following warnings must be observed:
 - 1.6.1. Turn off the electrical and water supplies before removing the cover.
 - 1.6.2. Mains connections are exposed when the cover is removed.
 - 1.6.3. Refer to the wiring diagram before making any electrical connections (see section "Wiring Diagram").
 - 1.6.4. Ensure all electrical connections are tight, to prevent them overheating.

2. Caution!

- 2.1.** Follow all warnings, cautions and instructions contained in this guide, and on or inside the appliance.

- 2.2.** The electrical installation must comply with the "Requirements for Electrical Installations" commonly referred to as BS 7671 the "IEE Wiring Regulations", or any particular regulations and practices, specified by the local electricity supply company in force at the time of installation. The installation should be carried out by an electrician or contractor who is "Part P" (Building Regulations) registered, or is a member of an association such as:
 - 2.2.1.** National Inspection Council for Electrical Installation and Contracting (NICEIC), throughout the UK.
 - 2.2.2.** The Electrical Contractors Association (ECA), England and Wales.
 - 2.2.3.** The Electrical Contractors Association of Scotland (ECAS).

- 2.3.** The plumbing installation must comply with the requirements of UK Water Regulations/Bye-laws (Scotland), Building Regulations or any particular regulations and practices, specified by the local water company. The installation should be carried out by a plumber or contractor who is registered, or is a member of, an association such as:
 - 2.3.1.** Institute of Plumbing (IOP), throughout the UK.
 - 2.3.2.** National Association of Plumbing, Heating and Mechanical Services Contractors (NAPH & MSC), England and Wales.
 - 2.3.3.** Scottish and Northern Ireland Plumbing Employers' Federation (SNIPEF), Scotland and Northern Ireland.

Pack Contents Checklist

Tick the appropriate boxes to familiarize yourself with the part names and to confirm that the parts are included.

1. Mira Sport Max 10.8 kW

1 x Mira Sport Max



1 x Olive

1 x Compression Nut



3 x Fixing Screws



3 x Wall Plugs



2 x Case Inserts

2. Documentation

1 x Installation and User Guide

1 x Installation Template

1 x Installer Checklist

1 x Guarantee Card

3. Mira Logic Electric Shower Fittings

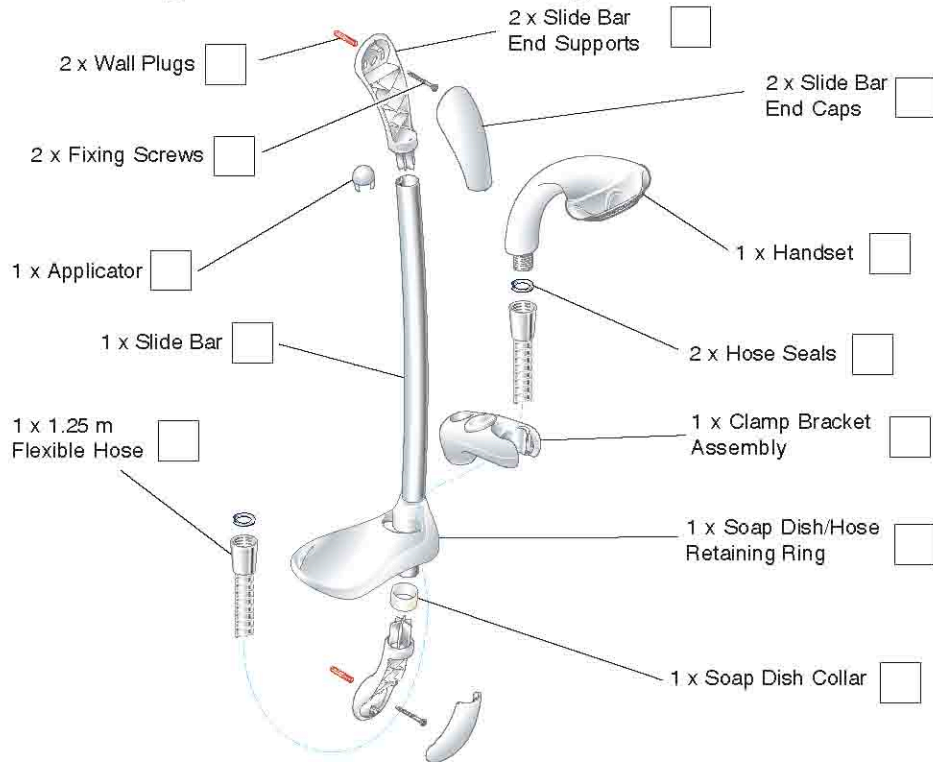

Specifications

1. Plumbing

- 1.1. Minimum maintained inlet pressure 100 kPa (1.0 bar) for satisfactory operation.
- 1.2. Maximum static inlet pressure 1000 kPa (10 bar).
- 1.3. Minimum static pressure 20 kPa (0.2 bar) to keep the flow valve closed.

2. Electrical

- 2.1. The Mira Sport Max 10.8 kW requires a 45 Amp fuse.
- 2.2. The terminal block will accept cable up to 16 mm².

3. Standards and Approvals

- 3.1. The Mira Sport Max complies with all relevant directives for CE marking.

Installation Requirements

Read the section “Important Safety Information” first.

Plumbing Checklist

1. Minimum maintained inlet pressure = 100 kPa (1.0 bar).
Maximum static inlet pressure = 1000 kPa (10 bar).
2. Water treatment device (if required).
3. Free flowing isolating valve.
4. Positioned over water catchment area.
5. Fitted to finished wall surface.
6. No sharp hose kinks.
7. Fittings positioned with greater than 25 mm gap or outlet double checkvalve fitted.
8. Supply pipework flushed clear.
9. Watertight inlet connection and fittings.
10. Case inserts fitted and Cover secured correctly.

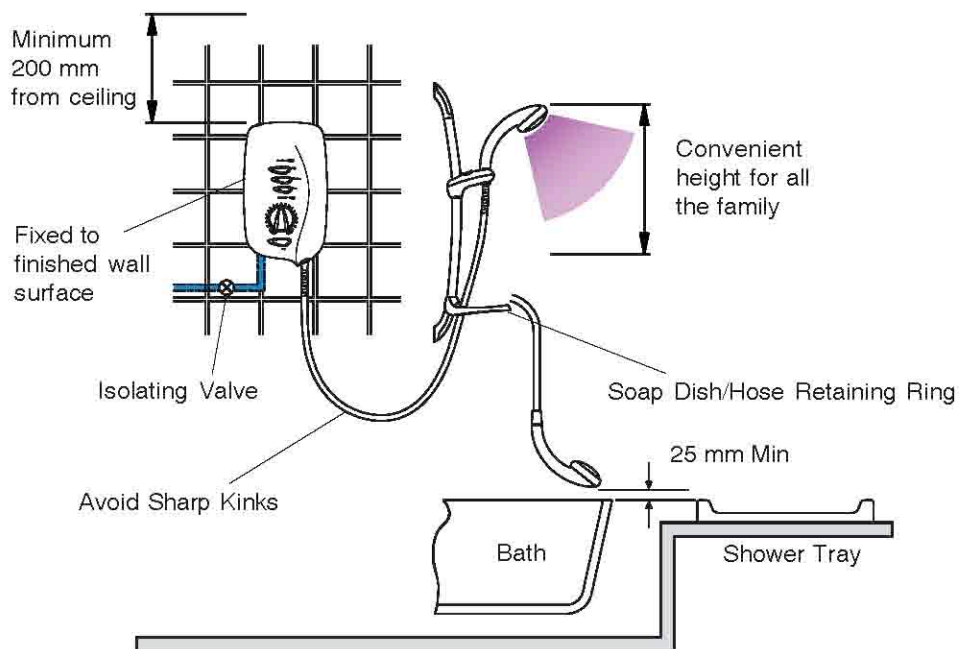

Plumbing (checklist in detail)

1. The appliance is designed to operate with a minimum **maintained inlet pressure of 100 kPa (1.0 bar)** up to a **maximum static inlet pressure of 1000 kPa (10 bar)**.
2. When installed in very hard water areas (above 200 ppm temporary hardness) your installer may advise the installation of a water treatment device, to reduce the effects of limescale formation. Your local water company will be able to advise the hardness of water in your area.
3. It is recommended that a non-restrictive (free flowing) isolating valve is fitted in the cold water supply pipe to allow the complete maintenance of the Mira Sport Max. **Do not** use a valve with a loose washer plate (jumper) as this can lead to a build up of static pressures.
4. The appliance is suitable for installation within the shower area. It is fitted with a pressure relief device and must be positioned over a water catchment area with the controls at a convenient height for all users.
5. The appliance must be fitted **onto** a finished flat and even wall surface (this wall surface should be tiled or waterproofed). **Do not** fit the appliance to the wall and tile up to the case. For safety requirements, an air gap must be left behind the appliance.
6. Avoid layouts where the shower hose will be sharply kinked. This may reduce the life of the hose.
7. A Soap Dish/Hose Retaining Ring is supplied to prevent the handset from dropping below the spill-over level of the bath or shower, which could lead to contamination from back-siphoning. The supplied Hose Retaining Ring should meet the great majority of user requirements for shower installations with flexible outlet fittings. However, there will be occasions when it will not provide a suitable solution. In these instances an **outlet** double checkvalve, e.g. a Mira DCV-H, **must** be fitted. This will increase the required supply pressure typically by 10 kPa (0.1 bar) (see section "Accessories").
8. Supply pipework **must** be flushed to clear debris before connecting to the appliance.
9. To avoid damage to the case when soldered fittings are used, pre-solder the pipework and fittings before connecting them to the inlet connector assembly. Refrain from applying excessive force when making any connections. Always provide mechanical support when making the plumbing connections.
10. The appliance is fitted with a brass inlet compression assembly for connecting to a 15 mm supply pipe from the top, bottom or back. Double checkvalves, fitted in the inlet supply to the appliance, cause a pressure build-up, which could exceed the maximum static inlet pressure and damage the appliance.

Read the section “**Important Safety Information**” first.

Electrical Checklist

1. Electrical supply fuse and consumer unit are adequate for the product.
2. Shower unit is earthed.
3. The minimum required supply cable size must conform to BS 7671.
4. Double pole isolating switch.
5. Do not twist live or neutral cable cores.
6. Electrical connections are tightly secured.
Do not strain terminal block.
7. Plumbing supply completed before electrical supply is turned on.

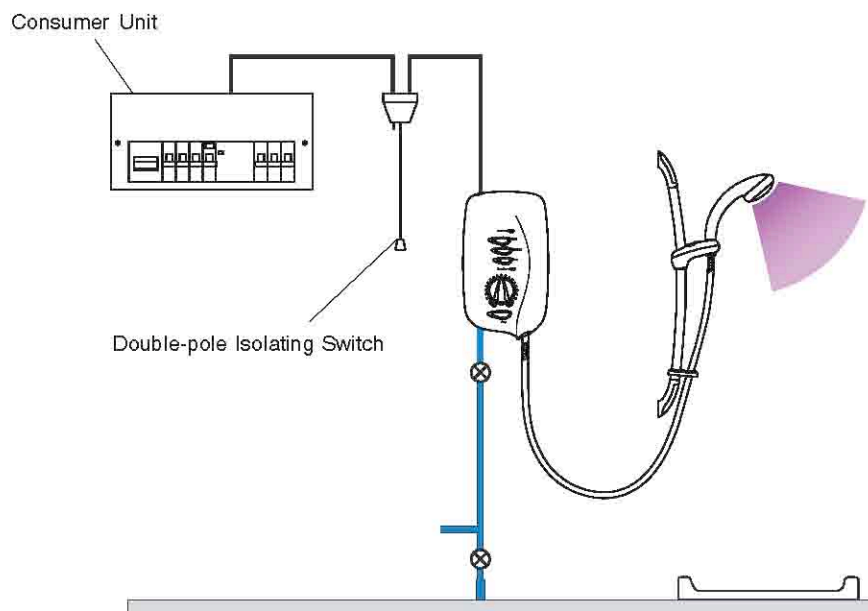

Electrical (checklist in detail)

1. In a domestic installation, the rating of the electricity supplier's fuse and the consumer unit must be adequate for the additional demand. The Mira Sport Max electric shower is a high power unit, therefore it is essential to contact your electricity supplier to ensure that the supply is adequate for the product. Voltage drop due to local heavy demand will reduce the shower's performance.
2. The Mira Sport Max **must be earthed** by connecting the supply-cable earth conductor to the earth terminal.
Supplementary bonding: Within the bathroom or shower room, all accessible conductive parts of electrical equipment and extraneous conductive parts (metal parts) that are likely to introduce earth potential, must be electrically bonded to earth using a minimum cable size of 4.0 mm² if the cable is not mechanically protected, (2.5 mm² if mechanically protected).
3. Supply cable - refer to: "**Electrical Checklist**".
4. **As a guide only**, and in accordance with BS 7671 we recommend close circuit protection:

i.e. 10.8 kW = 45 Amp

It is strongly recommended that a 30 mA Residual Current Device (RCD) is included in the electrical circuit. This may be part of the consumer unit or a separate unit. A separate, permanently connected supply is taken from the consumer unit to the appliance through a double-pole switch, which has at least 3 mm contact separation. The switch can be a ceiling mounted pullcord type within the shower room or a wall mounted switch in an adjacent room.
5. **DO NOT** twist the individual cable cores of either the live or neutral conductors, as this will prevent them from entering the terminal block.
6. **DO NOT** exert strain on the terminal block. Ensure that the electrical connections are tightly screwed down.
7. **DO NOT** turn on the electrical supply until the plumbing has been completed.

Installation

Mira Sport Max

Read the section “Important Safety Information” first

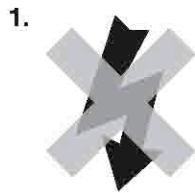

Electrical supply is turned off at the mains.

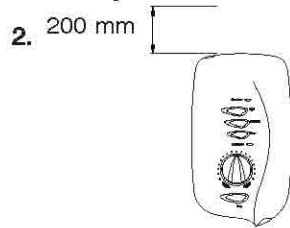

200 mm minimum from ceiling.

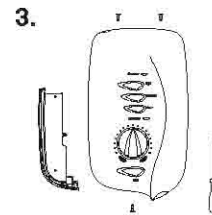

Remove three screws.



Remove Cover and determine supply pipe position.

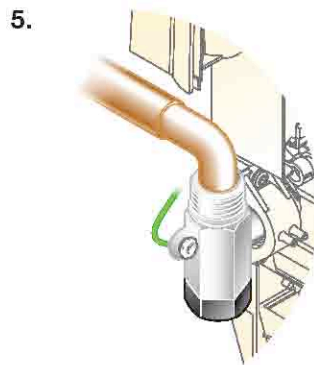

For back inlet use soldered elbow. **Do not** trap green wire.

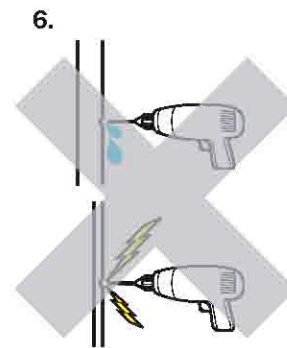

CAUTION! Do not drill into buried cables or pipes.

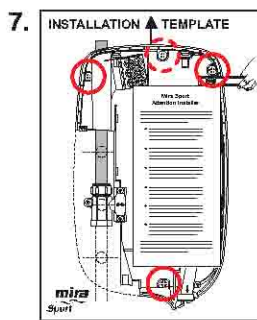

Drill and plug* the three holes using template.

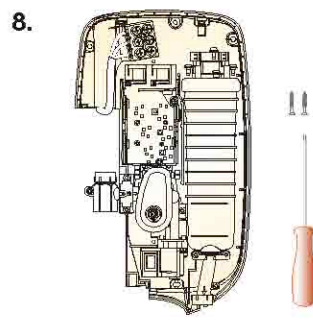

Fix appliance to wall.

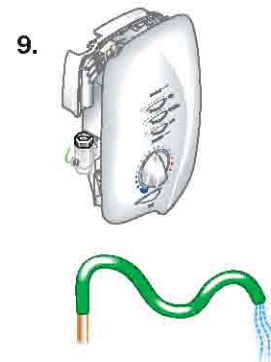

Flush a minimum of 10 litres (2 gallons) through pipework.

* Alternative fixings for some wall structures are not supplied.

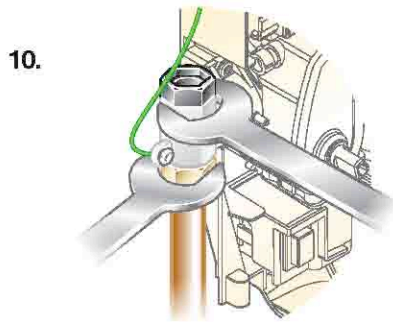

Connect supply pipe.
Do not overtighten!

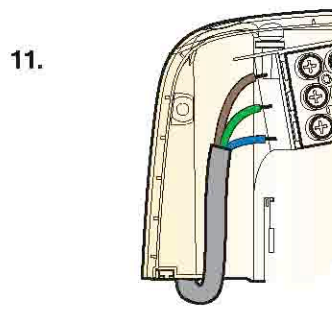

Feed cable into case. Fit Earth sleeve (not supplied) and strip insulation.
Do not twist cable cores.

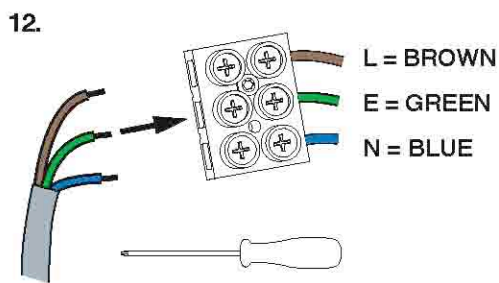

Firmly connect the conductors. **Do not** exert strain on the terminal block.

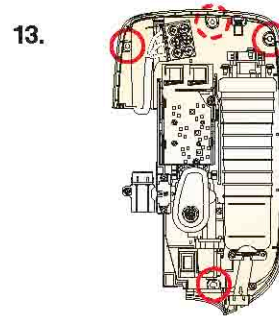

Make sure wires are clear of cover fixing holes.

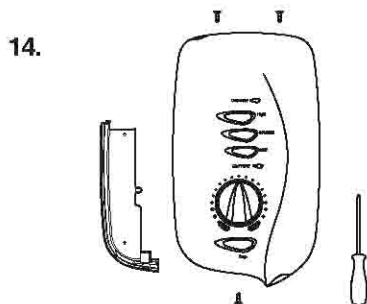

Refit the service tunnel and cover. Make sure they fit correctly.
Do not overtighten screws.

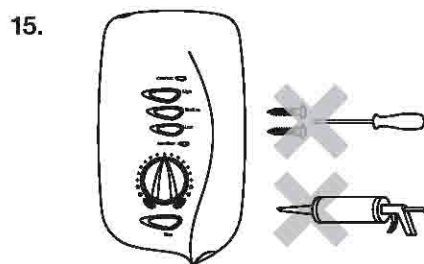

Do not use alternative screws to secure the cover. This can cause internal damage to the appliance.
Do not seal around the back of the appliance.

Mira Logic Electric Shower Fittings

Read the section “Important Safety Information” first

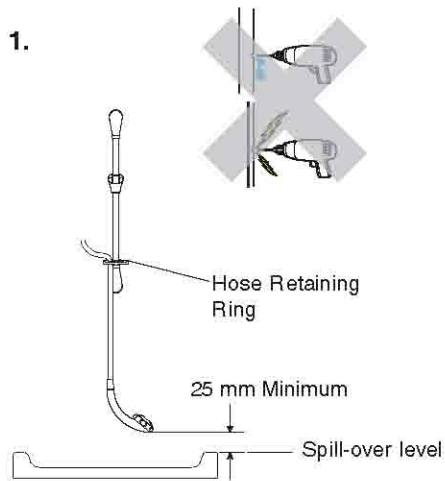

Position as shown to prevent back siphonage.

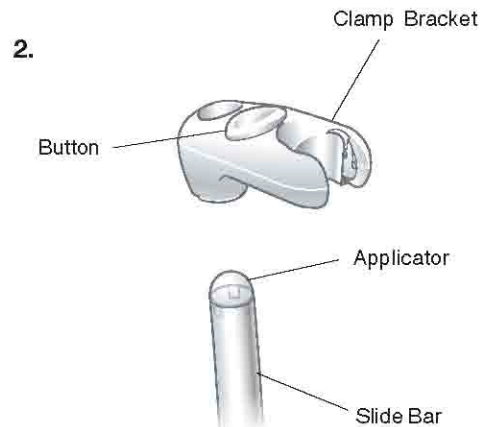

Depress button **FULLY** and assemble Clamp Bracket. Release button and remove Applicator.

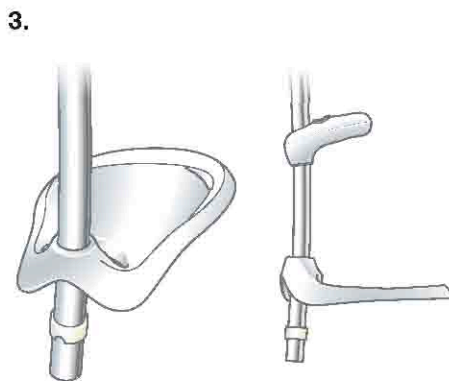

Slide the Soap Dish/Hose Retaining Ring and the Soap Dish Support Collar onto the Slide Bar below the Clamp Bracket.

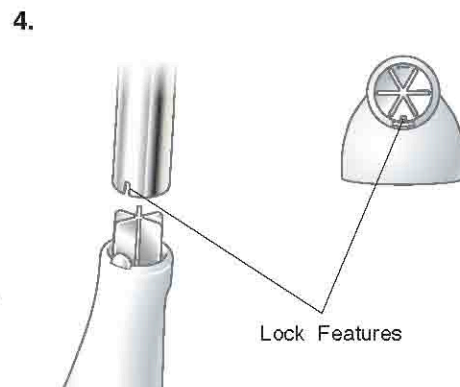

Fit both the top and bottom Supports. Make sure the slots are aligned to fit fully home.

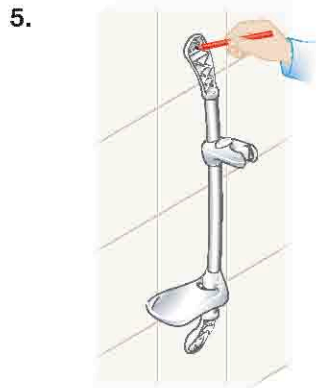

Mark the position of the middle slot on both top and bottom Supports.

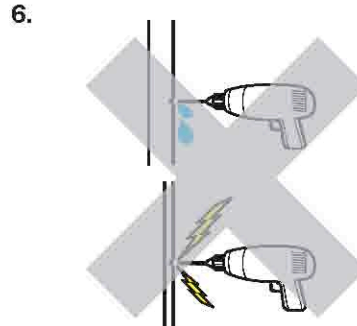

CAUTION! Do not drill into buried cables or pipes.

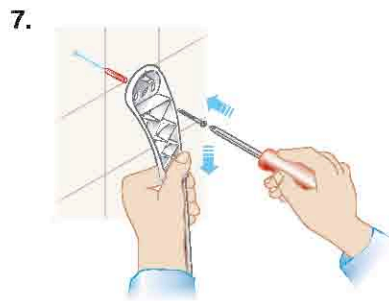

First fix the bottom Slide Bar Support and fully tighten the screw*. Then fix the top Slide Bar Support whilst pressing it down, to keep the whole assembly together.

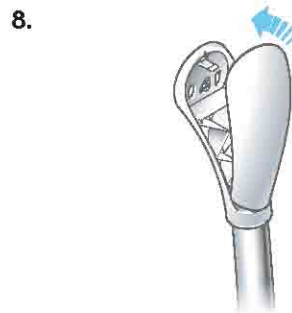

Fit the End Caps to the Slide Bar Supports.

9.
Fit the Hose to both the Handset and the Shower outlet, remembering to pass it through the Soap Dish/Hose Retaining Ring. **Do not** overtighten the Hose connections.

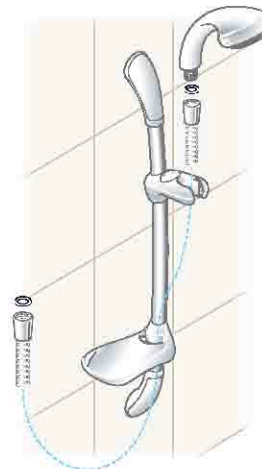

* Alternative fixings for some wall structures are not supplied.

Commissioning

1. Pretesting Your Mira Sport Max

If you are unsure how an electric shower works, please read through the **User Instructions** section before continuing.

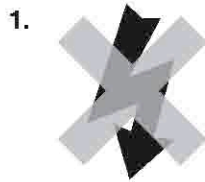

1. Electrical supply is turned off at the mains.

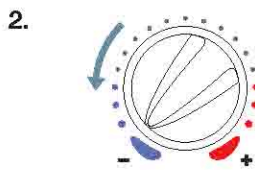

2. Turn control to full cold.

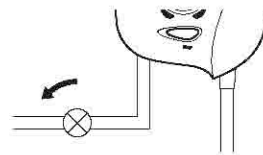

3. Turn water supply fully on.



4. Check for water leaks.

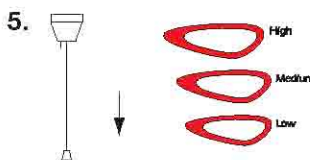

5. Switch on electrical supply.

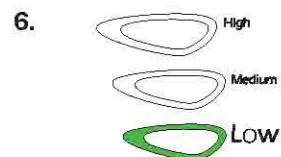

6. Push LOW button.

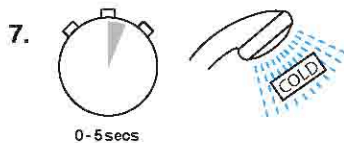

7. Water will be at full force and at a cool temperature.

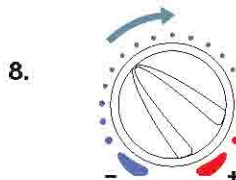

8. Turn control slowly. Temperature remains cool and flow is reduced.

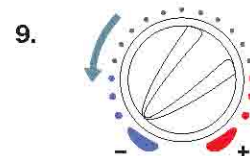

9. Turn control to full cold.

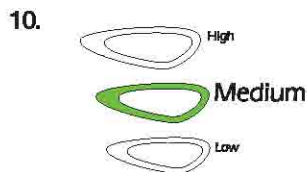

10. Push MEDIUM button.

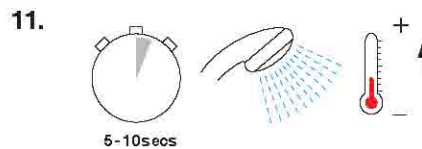

11. The temperature will rise slightly.

User Instructions

1. Warning!

- 1.1. **DO NOT** operate this appliance if it appears to be frozen. Allow the appliance to thaw and then contact your installer before using again.
- 1.2. **DO NOT** operate this appliance if water leaks from the pressure relief valve: maintenance will be required before the appliance can be safely used.
- 1.3. There are no user serviceable components beneath the cover of this appliance. Only a competent tradesperson should remove the cover.
- 1.4. If any of the following conditions occur, isolate the electricity and water supplies. Contact your installer or refer to **“To contact us”**, on the back page of this guide.
 - 1.4.1. If water is leaking from inside the product.
 - 1.4.2. If the case is damaged.
 - 1.4.3. If the appliance begins to make an odd noise, smell or smoke.
 - 1.4.4. If the appliance shows signs of a distinct change in performance, indicating a need for maintenance.
 - 1.4.5. If the cover is not correctly fitted.

2. Caution!

- 2.1. **Read all of these instructions and retain this guide for later use.**
- 2.2. Pass on this guide in the event of change of ownership of the installation site.
- 2.3. Anyone who may have difficulty understanding or operating the controls of any shower should be attended whilst showering. Particular consideration should be given to the young, the elderly, the infirm, or anyone inexperienced in the correct operation of the controls.
- 2.4. When this appliance has reached the end of its serviceable life, it should be disposed of in a safe manner, in accordance with current local authority recycling, or waste disposal policy.

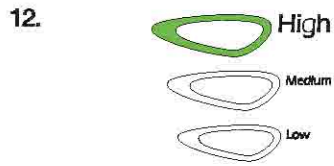

Push HIGH button.

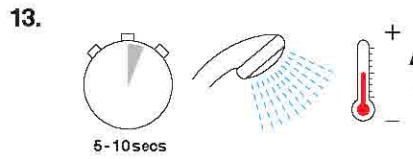

The temperature will rise further.

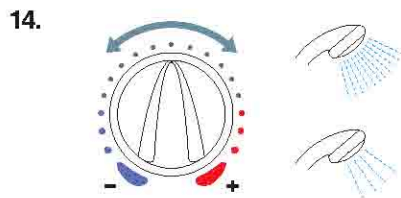

Adjust temperature as required. Flow rate will adjust automatically.

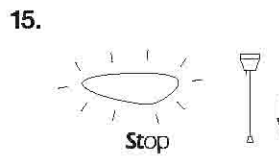

Press STOP and isolate power.

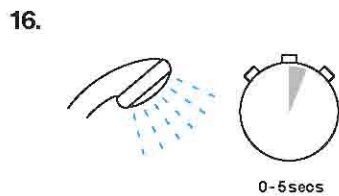

The shower will purge water from its tank for a few seconds.



Residual water may drain over a few minutes.

Note! A slight hissing sound may be heard from the Mira Sport Max during operation. High mains water pressure and high shower temperatures will effect the tone. This is quite normal in use.
When the shower is **not** running or the Stop button has been pressed, the three red heater lights will fade after a short time, indicating the product has entered a "stand-by" mode.

How Your Electric Shower Works

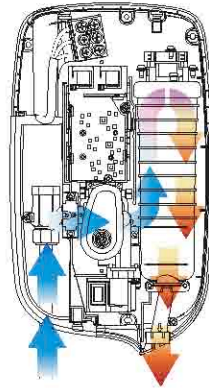

Hot water is produced by passing cold water through a heating tank.

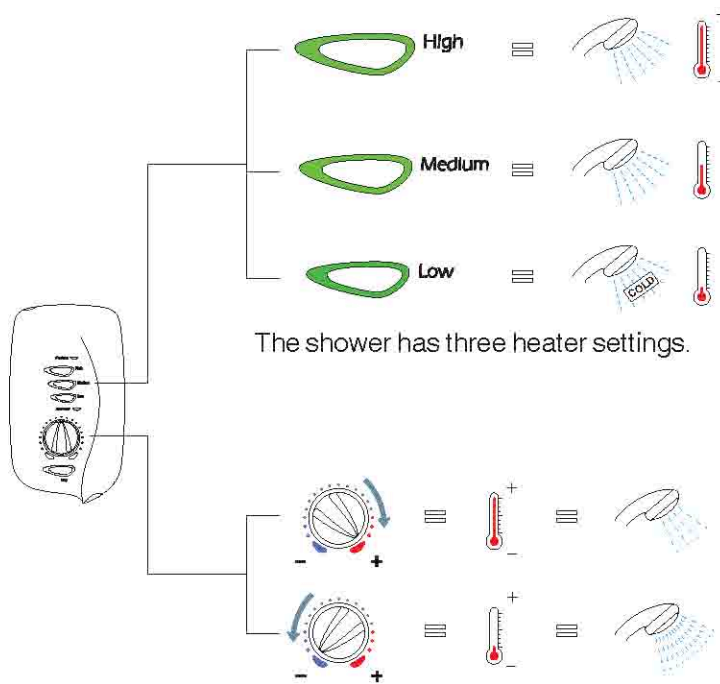

The shower has three heater settings.

The warmer the shower, the lower the flow rate and vice versa.

The Effect Of Seasonal Changes

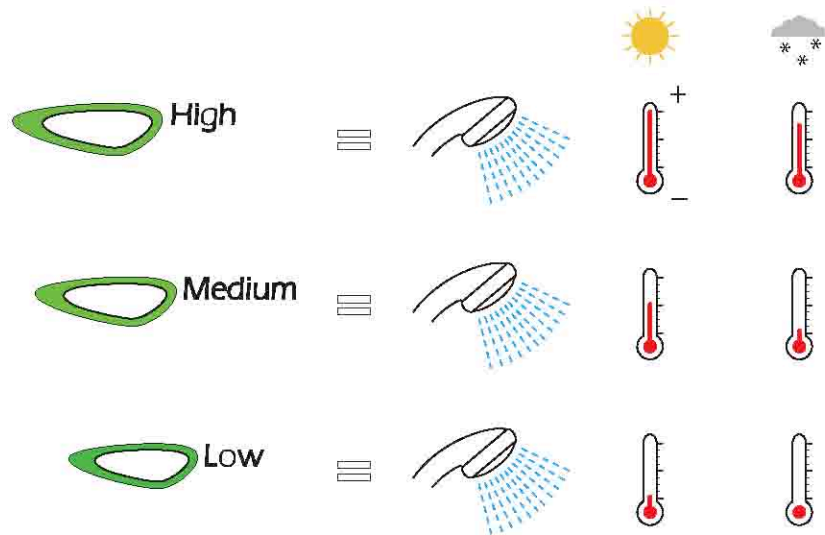

For a winter warm shower select HIGH
 For a summer warm shower select MEDIUM
 For a cold shower select LOW
 Adjust the temperature as required
 The flow rate will adjust automatically

The Effect Of Other Water Devices

Example of how shower temperature stabilizes due to pressure changes.

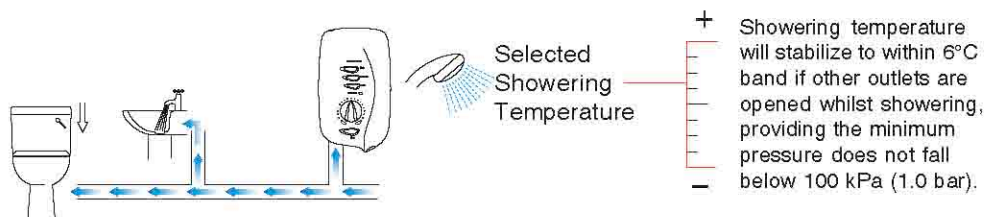

Water inlet pressure fluctuations due to other draw offs (e.g. flushing toilet) may cause the showering temperature to increase.

Using Your Shower

Read the section “Important Safety Information” first.

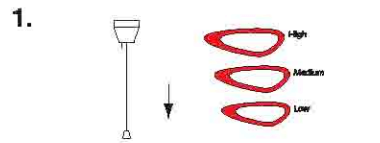

Switch on electrical supply.

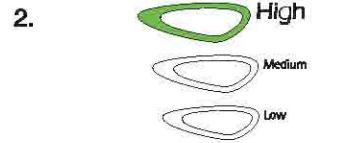

Push the HIGH button.



Check water temperature before entering shower.

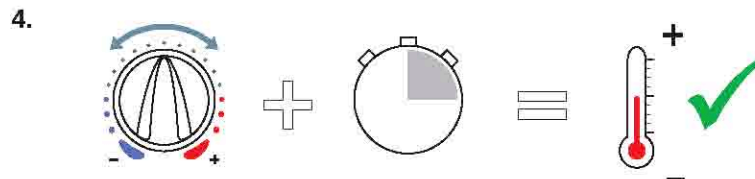

Allow 10-15 seconds for any temperature adjustments to reach the handset.

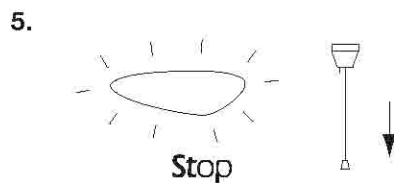

Press STOP button.
Shower will continue to run for a few seconds before stopping.



A small amount of water may continue to drain over a few minutes.

Note! When the shower is **not** running or the Stop button has been pressed, the three red heater lights will fade after a short time to indicate the product entering a "stand-by" mode.

Changing The Spray Setting

The handset has four different spray settings (Eco, Start, Soothe and Force).

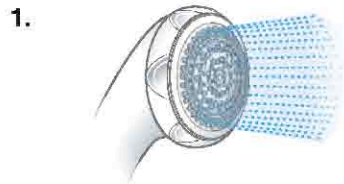

Eco

Turn the spray plate fully clockwise. A reduced flow of water will flow from the outer set of holes.



Start

Turn the spray plate anticlockwise until it "clicks" . Water will flow from the outer set of holes.



Soothe

Turn the spray plate anticlockwise until it "clicks" . Water will flow from the middle set of holes.



Force

Turn the spray plate anticlockwise until it "clicks" . Water will flow from the inner set of holes.

Adjusting The Clamp Bracket

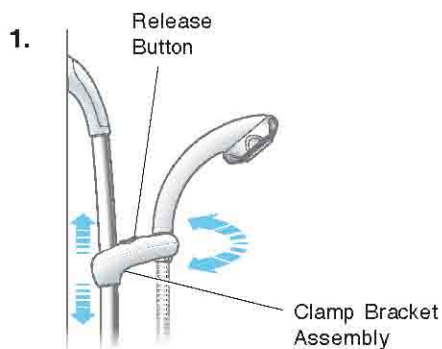

Depress the release button and slide the Clamp Bracket assembly to the required position.

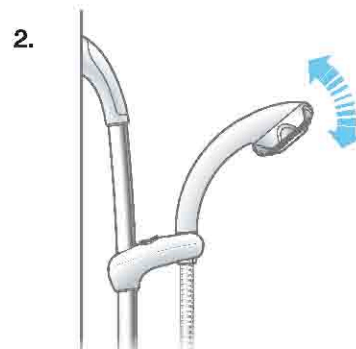

Move the handset to the required angle.

Fault Diagnosis

The trouble shooting information tabled below gives details on probable causes and remedies should difficulties be encountered whilst the shower is in operation.

Warning! There are no user serviceable components beneath the cover of the appliance.

ONLY A COMPETENT TRADESPERSON SHOULD REMOVE THE FRONT COVER!

Symptom	Over-heat Light	Low Flow Light	Heater Setting Low/Medium/High	Probable Cause	Possible Remedy
Appliance fails to operate.	OFF	OFF	Any	Electrical supply isolated at double pole switch.	Switch on electrical supply via the pullcord or wall mounted switch.
	OFF	OFF	Any	Fuse blown or MCB/RCD tripped, indicating possible electrical fault.	Renew the fuse or reset the MCB/RCD. If fault persists, contact your installer.
	OFF	OFF	Any	PCB failure.	Replace PCB assembly.
Shower cycles from hot to cold.	ON	ON	Medium/High	Handset blocked.	Remove and clean.
	ON	ON	Medium/High	Water pressure below minimum required for appliance operation.	Make sure incoming mains water stopcock and/or appliance isolating valve is fully turned on.
	ON	OFF	Medium/High	Temperature dial or Heater setting too high.	Push the Medium Button or turn the Temperature control until a cooler temperature is achieved.

Symptom	Over-heat Light	Low Flow Light	Heater Setting Low/Medium/High	Probable Cause	Possible Remedy
Unable to select a cool enough shower.	ON	OFF	High	Due to the rise in mains water supply temperature, the Heater setting may be too high.	Select Medium Heater setting and adjust the Temperature control until a suitable temperature is achieved.
Handset dripping.	OFF	OFF	Any	Insufficient water supply pressure for shut off.	The minimum static pressure to ensure shut off and prevent dripping is 20 kPa (0.2 bar). Note: If other appliances are operating, static pressure may drop below 20 kPa (0.2 bar). Contact local water company. Renew the Flow Valve.
	OFF	OFF	Any	Flow Valve faulty.	Replace.
Low or No flow.	ON	ON	Any	Water supply pipework or inlet filter restricted by a blockage or partial blockage.	Flush supply pipe. Clean Inlet Filter.
	ON	ON	Any	Insufficient water supply pressure/ flow for operation.	Contact local water company. Supply pressure must be a minimum of 100 kPa (1.0 bar). Note: If other appliances are operating, pressure may drop below 100 kPa (1.0 bar).
	ON	ON	Any	Other outlets (e.g. toilet, garden hose, washing machine, etc.) drawing water while the shower is being used.	Turn off other appliances whilst shower is in use.

Symptom	Over-heat Light	Low Flow Light	Heater Setting Low/Medium/High	Probable Cause	Possible Remedy
Low or No flow (Cont).	ON	OFF	Any	Handset blocked.	Remove and clean.
	ON	OFF	Any	Service tunnel or cover not fitted correctly causing Stop button not to operate.	Check case inserts are cut and fitted correctly. Check services (electrical or plumbing) are not interfering with location of service tunnel or cover.
	ON	OFF	Any	Flow Valve faulty.	Replace.
	ON	OFF	Any	Heater Tank excessively scaled.	Replace. In hard water areas consider the use of a water softener.
Operation of Temperature Control has little or no effect on water temperature.	ON	ON	Medium/High	Handset or Inlet Filter blocked.	Remove and clean.
	ON	OFF	Medium/High	Flow Valve faulty.	Replace.
	ON	OFF	Medium/High	Heater Tank failure.	Replace.
	OFF	OFF	Medium/High	PCB failure.	Replace PCB assembly.
No change in temperature between Low/Medium/High setting.	ON	ON	Any	Insufficient mains water pressure.	Contact local water company.
	ON	OFF	Any	Possible failure of Flow Valve or Heater Tank.	Use a suitable device to check the continuity of the Heater Tank and replace parts as necessary.
	OFF	OFF	Any	PCB failure.	Replace PCB assembly.

Symptom	Over-heat Light	Low Flow Light	Heater Setting Low/Medium/High	Probable Cause	Possible Remedy
Water will not turn off.	ON	OFF	Any	Flow Valve, Solenoid, or Stop switch faulty.	Replace as necessary.
	ON	ON	Any	Supply pressure below 20 kPa (0.2 bar).	Contact local water company. Check mains water static pressure.
Appliance fails to produce hot water when set on Medium/High Heater Setting	ON	ON	Medium/High	Insufficient water supply.	Contact local water company.
	ON	OFF	Medium/High	Possible failure of the thermal switch.	Use a suitable device to check the continuity of the Heater Tank and replace parts as necessary.
	ON	OFF	Medium/High	Heater Tank failure.	Replace.

Maintenance

Handset - Cleaning

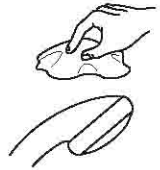

Clean with mild washing up detergent or soap solution. Wipe dry with soft cloth.



Poor shower performance can be avoided by cleaning spray plate. Use thumb or soft cloth to wipe rubber nozzles. The Handset must also be descaled regularly.

Inlet Filter - Cleaning/Renewing

Read the section “Important Safety Information” first.

1.



Electrical supply is turned off at the mains.

2.

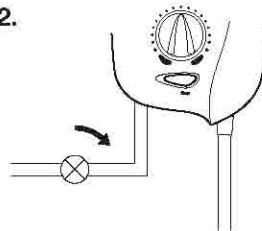

Turn water supply fully off.

3.

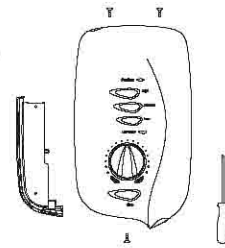

Remove three screws, cover and service tunnel.

4.

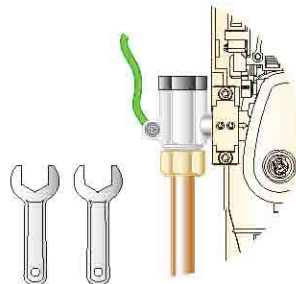

5.



Hold a wrench across the flats of the metal connector. Unscrew the filter using another wrench as shown. Clean or renew the filter as necessary. Refit in reverse order making sure the filter is screwed fully home. **Do not** overtighten. Make sure plumbing connections are sealed before restoring electricity supply.

Dimensions

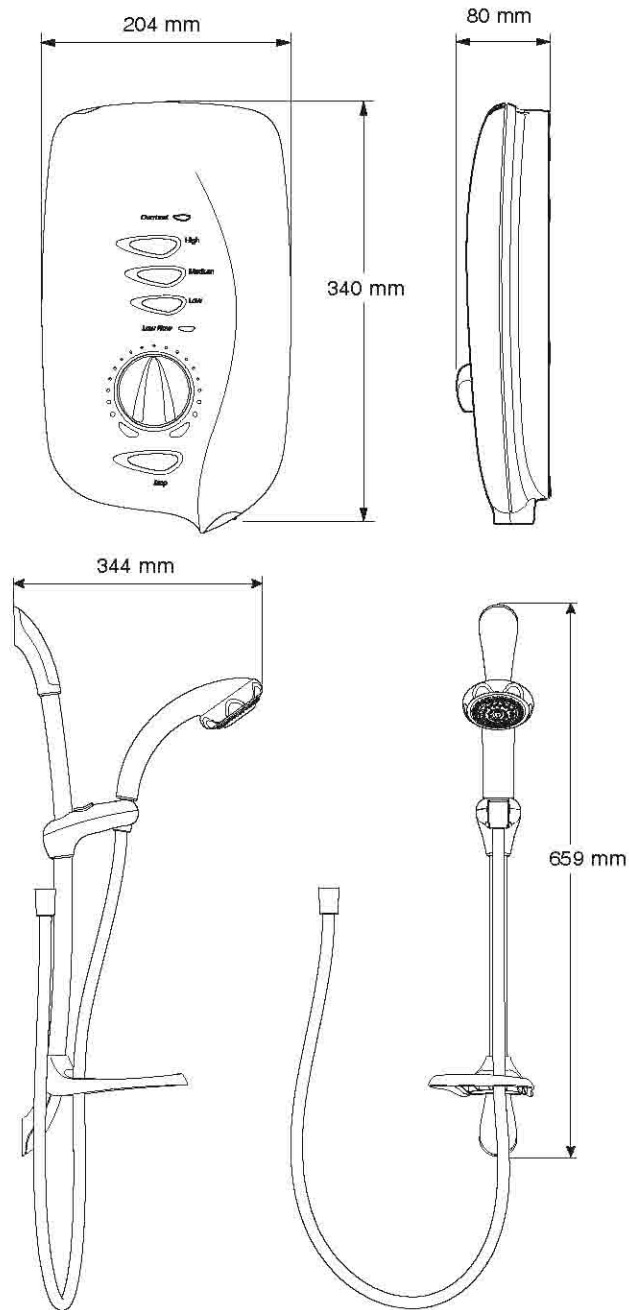

Wiring Diagram

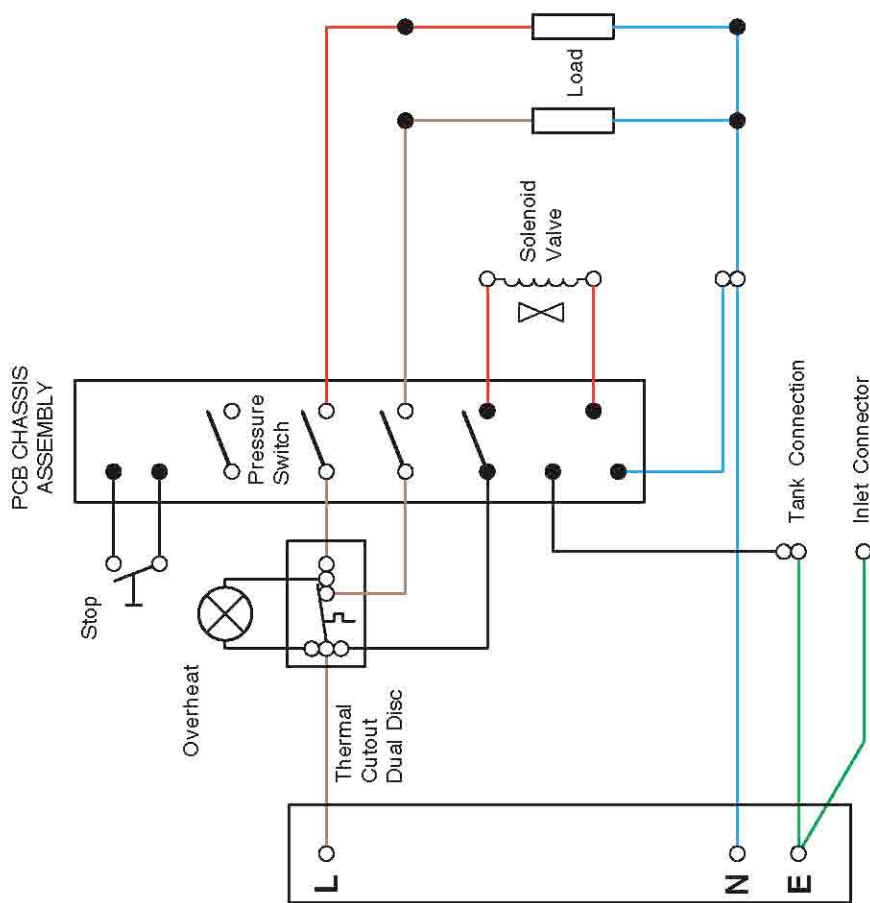

Internal Wiring Diagram

Accessories

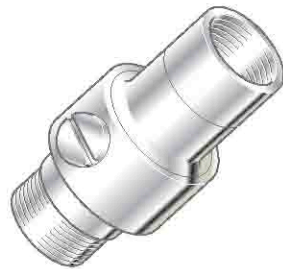

DCV-H: An outlet double check valve, designed to prevent the backflow or backsiphonage of potentially contaminated water, through shower controls which are fitted with a flexible hose as part of the outlet shower fitting. Available as an optional accessory from all Mira Showers stockists.

Spare Parts

Mira Sport Max Spare Parts List

405.58	Inlet Connector Assembly
406.27	Inlet Filter (with 'O' seal fitted)
416.38	Clamp Bracket (Inlet)
416.41	Thermal Switch
416.48	Latching Switch
416.51	Solenoid Coil
1563.505	Heater Tank 10.8 kW 240 V AC (9.9 kW 230 V AC)
1563.508	Flow Valve Assembly 10.8 kW
1563.510	PCB Assembly
1563.512	Cover Assembly Max
1563.513	Screw Pack - components identified 'A'
1563.515	Overheat Neon Assembly
1563.516	Outlet Connector
1563.517	Service Tunnel and Insert
1563.518	Component Pack - components identified 'B'
1563.519	Terminal Block Assembly
1563.521	Wire Pack 10.8 kW
1563.522	Cover Seal (not shown)

Mira Sport Max Spare Parts Diagram

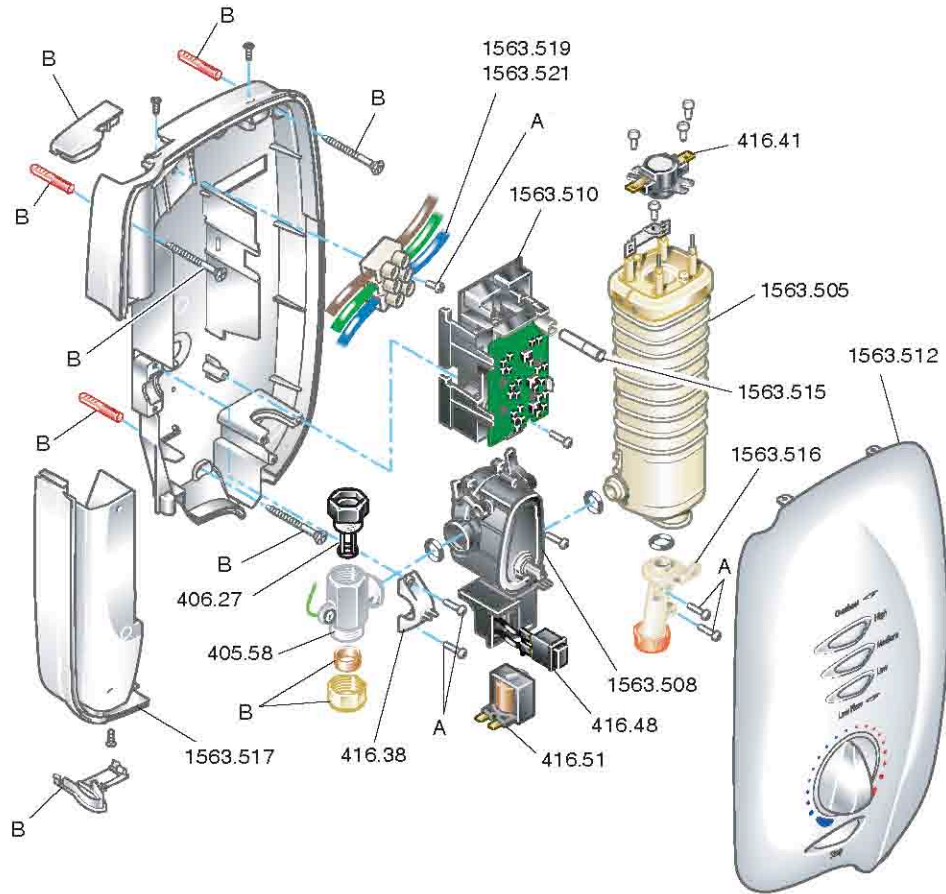

Mira Logic Electric Shower Spares List

450.01	Hose 1.25 m – chrome
450.03	Adjuster Ring
450.06	Clamp Bracket Assembly – white
450.08	Service Pack 'O' seals – components identified 'A'
450.17	Slide Bar Wall Fixing Pack – components identified 'B'
450.26	Slide Bar Support Assembly – white – components identified 'D'
450.28	Slide Bar – chrome
450.36	LC Spray Plate Pack – white
632.73	Hose Washer
1563.257	Adjustable Handset Assembly
1563.552	Soap Dish/Hose Retaining Ring

Mira Logic Electric Shower Fittings Spare Parts Diagram

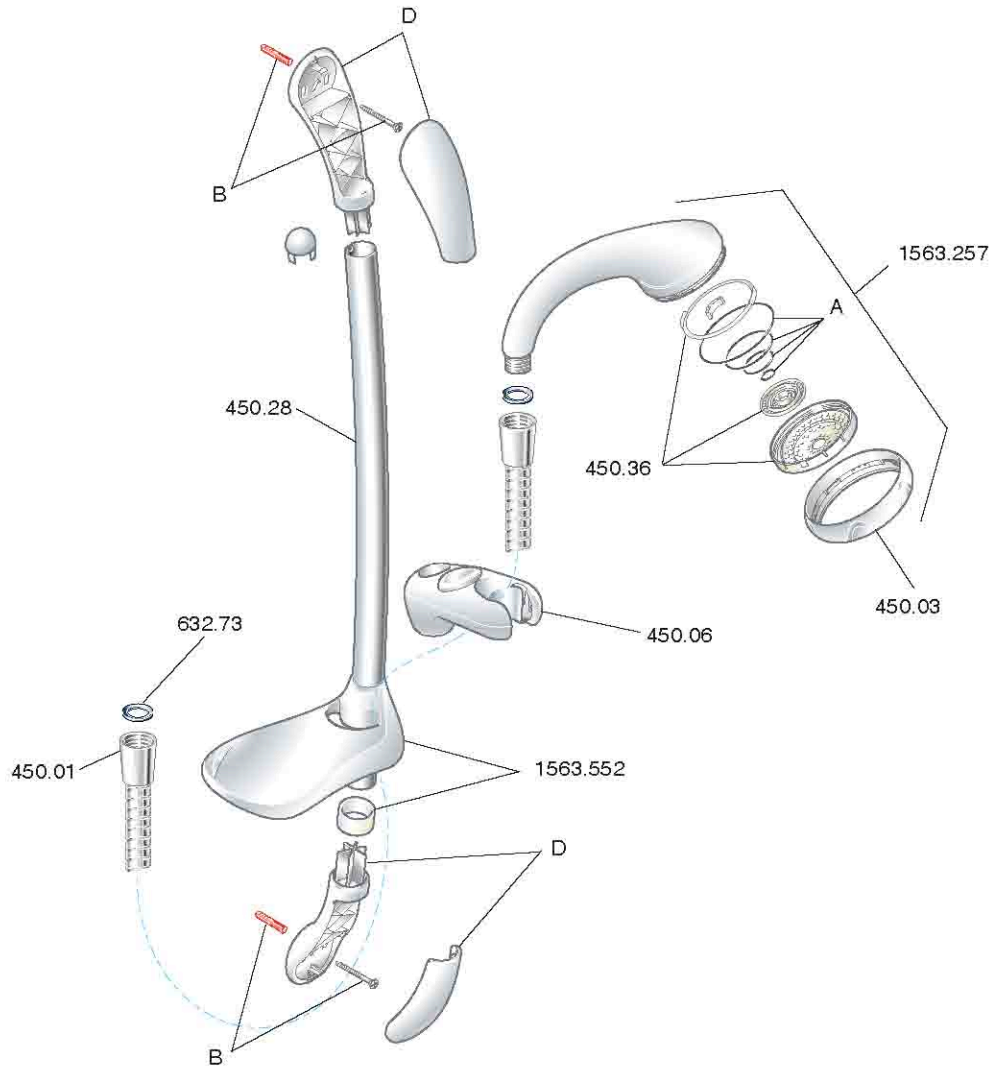

Notes

Notes

Customer Service

Guarantee of Quality

Mira Showers guarantee your product against any defect in materials or workmanship for the period shown in the Guarantee Registration Document Included with your shower.

Alternatively, to confirm the applicable guarantee period please contact Customer Services.

To validate the guarantee, please return your completed registration card.

Within the guarantee period we will resolve defects, free of charge, by repairing or replacing parts or modules as we may choose.

To be free of charge, service work must only be undertaken by Mira Showers or our approved agents in Northern Ireland and Republic of Ireland.

Service under this guarantee does not affect the expiry date. The guarantee on any exchanged parts or product ends when the normal product guarantee period expires.

Not covered by this guarantee:

Damage or defects arising from incorrect installation, improper use or lack of maintenance, including build-up of limescale.

Damage or defects if the product is taken apart, repaired or modified by any person not authorised by Mira Showers or our approved agents.

This guarantee is in addition to your statutory and other legal rights.

Before using your shower

Please take the time to read and understand the operating and safety instructions detailed in this manual.

What to do if something goes wrong

If when you first use your shower it doesn't function correctly, first contact your installer to check that installation and commissioning are satisfactory and in accordance with the instructions in this manual. We are on hand to offer you or your installer any advice you may need.

Should this not resolve the difficulty, simply contact our Customer Services who will give every assistance, and if necessary arrange for our service engineer to visit.

If later the performance of your shower declines, consult this manual to see whether simple home maintenance is required. Please call our Customer Services to talk the difficulty through, request service under guarantee if applicable, or take advantage of our comprehensive After-Sales service.

As part of our quality and training programme calls may be recorded or monitored.

Our Customer Services Team is comprehensively trained to provide every assistance you may need: help and advice, spare parts or a service visit.

Spare Parts

We maintain an extensive stock of spares, and aim to have functional parts available for ten years from the date of final manufacture of the product.

Spares can be purchased from approved stockists or merchants (locations on request) or direct from Customer Services.

Spares direct will normally be despatched within two working days. Payment can be made by Visa or MasterCard at the time of ordering. Should payment by cheque be preferred a pro-forma invoice will be sent.

Note! In the interests of safety, spares requiring exposure to mains voltages can only be sent to competent persons.

Service

Our Service Force is available to provide a quality service at a reasonable cost. You will have the assurance of a Mira trained engineer/agent, genuine Mira spares, and a 12 month guarantee on the repair.

Payment should be made directly to the Service Engineer/Agent, using Visa, MasterCard or a cheque supported by a banker's card.

To contact us

England, Scotland & Wales

Mira Showers Customer Services

Telephone: 0870 241 0888

8:30 am to 5:00 pm Working days (4:30 pm Friday)

8:30 am to 12.30 pm Saturday

E-mail: technical@mirashowers.com

Fax: 01242 282595

By Post: Cromwell Road

Cheltenham

Gloucestershire

GL52 5EP

Northern Ireland

Wm H Leech & Son Ltd

Telephone: 028 9044 9257 – Mon to Fri 9 am-5pm

Fax: 028 9044 9234

Post: Maryland Industrial Estate

Ballygowan Road

Moneyreagh, Co Down

BT23 6BL

Republic of Ireland

Modern Plant Ltd

Telephone: 01 4591344 – Mon to Fri 9am to 5pm

Fax: Dublin 01 4592329

Post: Otter House

Naas Road

Clondalkin

Dublin 22

Mira Showers
Kohler Mira Ltd
Cromwell Road,
Cheltenham GL52 5EP.

Mira is a registered trade mark of
Kohler Mira Limited.
The company reserves the right to alter
product specifications without notice.
www.mirashowers.com



mira
SHOWERS